

# MATÄLSKARE MATTRADITION

GB

DE

FR

IT



Design and Quality  
IKEA of Sweden





Please refer to the last page of this manual for the full list of IKEA appointed Authorized Service Centre and relative national phone numbers.

**ENGLISH**  
**DEUTSCH**  
**FRANÇAIS**  
**ITALIANO**

**5**  
**21**  
**37**  
**58**



Gehen Sie dazu auf die letzte Seite dieser Broschüre. Dort finden Sie eine Übersicht mit den entsprechenden Telefonnummern und Kontaktdaten unserer autorisierten Kundendienste.



Consultez la dernière page de ce manuel pour la liste complète des centre d'entretien et de réparation agréés IKEA avec leur numéro de téléphone respectifs.



Siete pregati di contattare il numero del Centro Assistenza Autorizzato incaricato da IKEA riportato sull'ultima pagina di questo manuale.

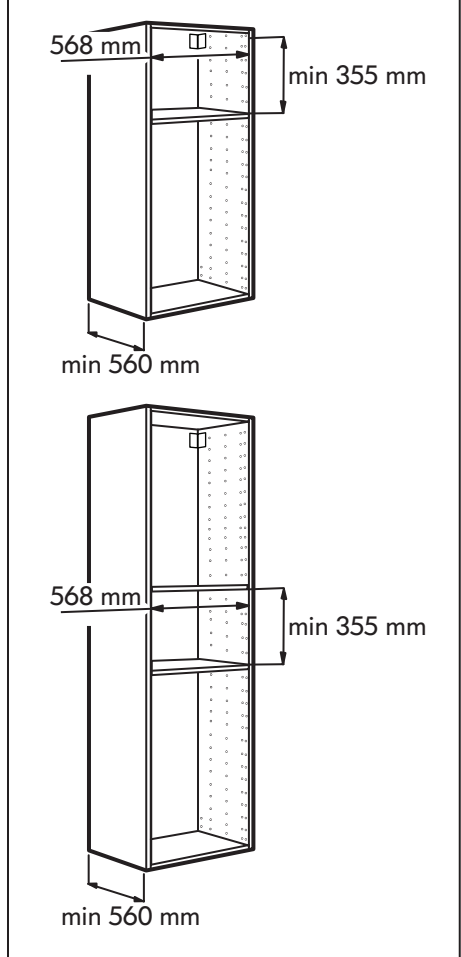
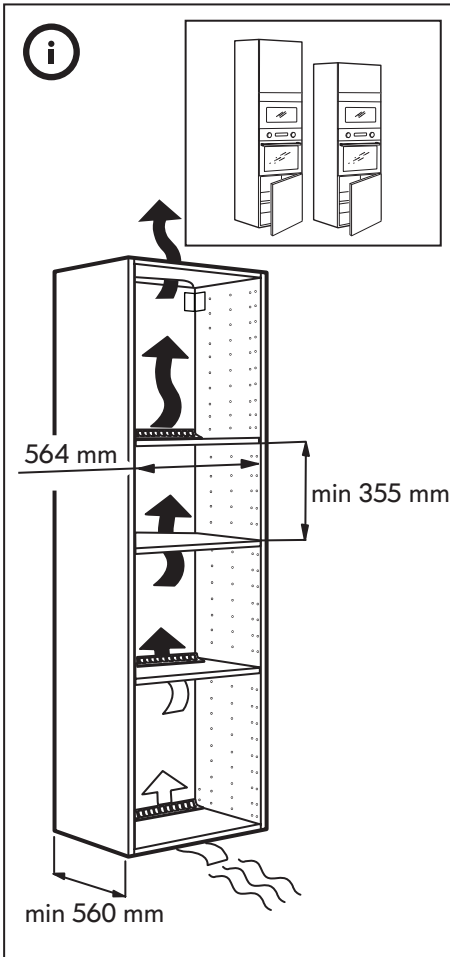
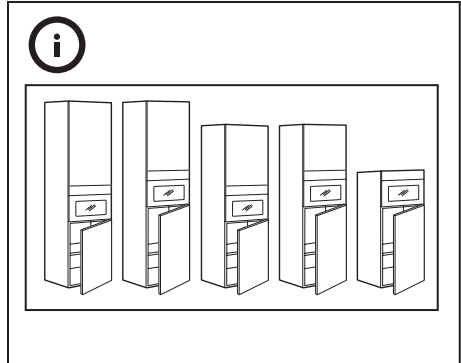
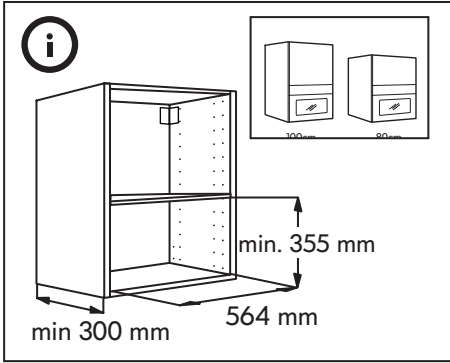

## Table of contents

Safety Information	5	Technical data	15
Product description	8	Installation	16
Control panel	9	Electrical connection	17
Daily use	9	Environmental concerns	18
What to do if ...	14	IKEA GUARANTEE	19

## Safety Information

Before using the appliance, read these safety instructions. Keep them nearby for future reference.

These instructions and the appliance itself provide important safety warnings, to be observed at all times. The manufacturer declines any liability for failure to observe these safety instructions, for inappropriate use of the appliance or incorrect setting of controls.

**⚠** Very young children (0-3 years) should be kept away from the appliance. Young children (3-8 years) should be kept away from the appliance unless continuously supervised. Children from 8 years old and above and persons with reduced physical, sensory or mental capabilities or lack of experience and knowledge can use this appliance only if they are supervised or have been given instructions on safe use and understand the hazards involved. Children must not play with the appliance. Cleaning and user maintenance must not be

carried out by children without supervision.

**⚠ WARNING!:** If the door or door seals are damaged, the oven must not be operated until it has been repaired – risk of injury.

**⚠ WARNING!:** Liquids and foods must not be heated in sealed containers – risk of explosion, heating of beverages can result in delayed eruptive boiling, care must be taken when handling the container – risk of burn.

**⚠** The microwave oven is intended for heating food and beverages. Do not dry food or clothing or heat warming pads, slippers, sponges and similar - risk of fire. When heating food in plastic or paper containers, remains vigilant on the oven - risk of fire.

**⚠** The contents of feeding bottles and baby food jars must be stirred or shaken and their temperature checked - risk of burn. Do not heat eggs in their shells and whole hard-boiled eggs - risk of explosion.

⚠ Only use utensils that are suitable for microwave cooking. Do not use metallic containers - risk of injury.

⚠ Only use a temperature probe recommended for this oven - risk of fire.

⚠ If smoke is emitted switch off or unplug the appliance and keep the door closed in order to stifle any flames.

⚠ If the appliance is installed 850 mm or more above the floor, take care not to displace the turntable when removing containers – risk of injury.

⚠ Do not use your microwave oven for deepfrying, because the oil temperature can not be controlled.

⚠ Metallic containers for food and beverages are not suitable during microwave cooking.

⚠ Do not remove the microwave inlet protection plates on the side of the cavity walls (certain models only). They prevent grease and food particles from entering the microwave inlet channels.

### PERMITTED USE

⚠ **CAUTION:** The appliance is not intended to be operated by means of an external switching device, such as a timer, or separate remote controlled system.

⚠ This appliance is intended to be used in household and similar applications such as: staff kitchen areas in shops, offices and other working environments; farm houses; by clients in hotels, motels, bed & breakfast and other residential environments.

⚠ This appliance is not for professional use. Do not use the appliance outdoors.

### INSTALLATION

⚠ The appliance must be handled and installed by two or more persons - risk of injury. Use protective gloves to unpack and install - risk of cuts.

⚠ Installation, including water supply (if any), electrical connections and repairs must be carried out by a qualified technician. Do not repair or replace any part of the appliance unless specifically stated in the user manual. Keep children away from the installation site. After unpacking the appliance, make sure that it has not been damaged during transport. In the event of problems, contact the dealer or your nearest Aftersales Service. Once installed, packaging waste (plastic, styrofoam parts etc.) must be stored out of reach of children - risk of suffocation. The appliance must be disconnected

from the power supply before any installation operation - risk of electric shock.

During installation, make sure the appliance does not damage the power cable - risk of fire or electric shock. Only activate the appliance when the installation has been completed.

⚠ This appliance is intended to be used built-in.

Do not use it freestanding or place into a cabinet.

After unpacking the appliance, make sure that the appliance door closes properly. In the event of problems, contact the dealer or your nearest After-sales Service.

### **ELECTRICAL WARNINGS**

⚠ It must be possible to disconnect the appliance from the power supply by unplugging it if plug is accessible, or by a multi-pole switch installed upstream of the socket in accordance with the wiring rules and the appliance must be earthed in conformity with national electrical safety standards.

⚠ Do not use extension leads, multiple sockets or adapters. The electrical components must not be accessible to the user after installation. Do not use the appliance when you are wet or barefoot.

Do not operate this appliance if it has a damaged power cable or plug, if it is not working properly, or if it has been damaged or dropped.

⚠ If the supply cord is damaged, it must be replaced with an identical one by the manufacturer, its service agent or similarly qualified persons in order to avoid a hazard - risk of electric shock.

**Product description**

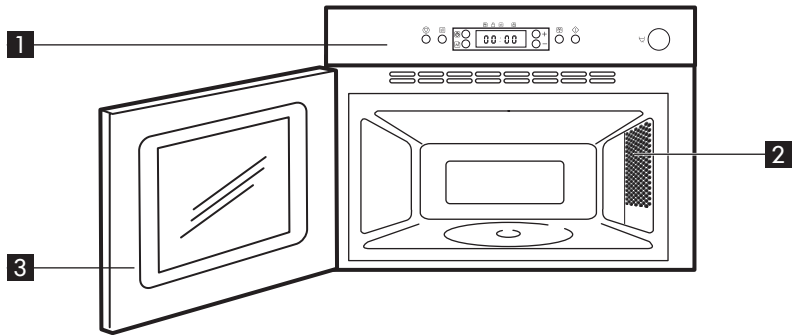

**1** Control Panel

**2** Cavity Lamp

**3** Door

**Accessories**

Turntable support

Glass turntable

Steamer

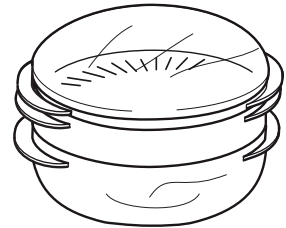
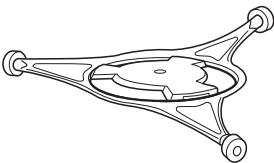

x1

x1

x1

**General**

There are a number of accessories available on the market. Before you buy, ensure they are suitable for microwave use.

Ensure that the utensils you use are oven proof and allow microwaves to pass through them before cooking.

When you put food and accessories in the microwave oven, ensure that they do not come in contact with the interior of the oven.

This is especially important with accessories made of metal or metal parts.

If accessories containing metal comes in contact with the oven interior, while the oven is in operation, sparking can occur and the oven could be damaged.

Always ensure that the turntable is able to turn freely before starting the oven.

**Turntable support**

Use the turntable support under the Glass turntable. Never put any other utensils on the turntable support.

- Fit the turntable support in the oven.

**Glass turntable**

Use the Glass turntable with all cooking methods. It collects the dripping juices and food particles that otherwise would stain and soil the interior of the oven.

- Place the Glass turntable on the turntable support.

**Steamer**

Use the steamer with the strainer in place for such foods as fish, vegetables and potatoes.

Always place the steamer on the Glass Turntable.



**Control panel**

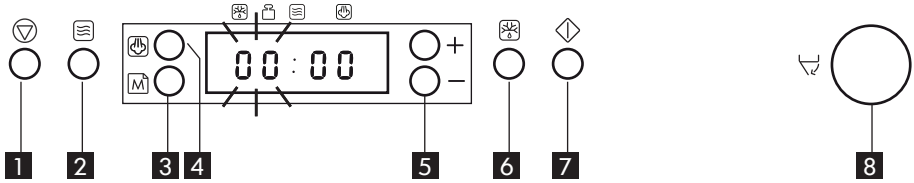

- 1** Stop button
- 2** Power button
- 3** Memo button
- 4** Steam button
- 5** + / - button  
(use this button to set time or weight)
- 6** Jet Defrost button
- 7** Start button
- 8** Door button  
(use this button to open the door)

**Daily use**

**Start protection / Key lock**

This automatic safety function is activated one minute after the oven has returned to “stand by mode“. (The oven is in “stand by” when the 24-hour clock is displayed or if the clock has not been set, when the display is showing the two small dots between the digits.

The door must be opened and closed e.g. putting food into it, before the safety lock is released. Else the display will show “DOOR“.

**To pause or stop cooking**

To pause cooking:

The cooking can be paused to check, turn or stir the food by opening the door. The setting will be maintained for 10 minutes.

To continue cooking:

Close the door and press the Start button ONCE. The cooking is resumed from where it was paused.

Pressing the Start button TWICE will increase the time by 30 seconds.

If you don't want to continue cooking:

Remove the food, close the door and press the Stop button

A beep will signal once a minute for 10 minutes when the cooking is finished.

Press the Stop button or open the door to cancel the signal.

**NOTE:** The oven will only hold the settings for 60 seconds if the door is opened and then closed after the cooking is finished.

**Cooling down**

When a function is finished, the oven carries out a cooling procedure. This is normal. After this procedure the oven switches off automatically.

**Kitchen timer** 

Use this function when you need a kitchen timer to measure exact time for various purposes such as cooking eggs or letting the dough rise before baking etc.

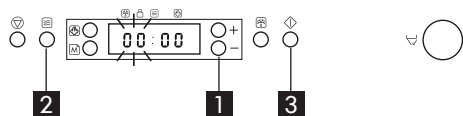

1. Press the +/- buttons to set the desired length of the timer.
2. Press the power button repeatedly to set the power to 0 W.
3. Press the Start button.

An acoustic signal will be heard when the timer has finished to count down.

**Clock** 

Keep the door open while setting the Clock. This gives you 5 minutes to complete the setting of the Clock. Otherwise, each step must be accomplished within 60 seconds.

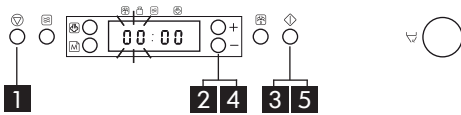

1. Press the Stop button (3 seconds) until the left-hand digit (hour's) flicker.
2. Press the +/- buttons to set the hours.
3. Press the Start button. (The two right hand digits (minutes) blink).
4. Press the +/- buttons to set the minutes.
5. Press the Start button again.

The Clock is set and in operation.

**NOTE:** When the appliance is first plugged in or after a power failure, the display is blank. If the clock is not set, the display will remain blank until the cooking time is set. If you wish to remove the Clock from the display once it has been set, simply press the Stop button once for 3 seconds and then press the Stop button once more. To reinstate the Clock, follow the above procedure.

**Cook and reheat with microwaves** 

Use this function for normal cooking and reheating, such as vegetables, fish, potatoes and meat.

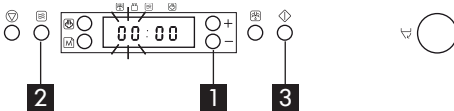

1. Press the +/- buttons to set the time.
2. Press the power button repeatedly to set the power.
3. Press the Start button.

Once the cooking process has been started: The time can easily be increased in 30-second steps by pressing the Start

button. Each press increases the time with 30 seconds. You may also alter the time by pressing the +/- buttons to increase or decrease the time.

Pressing the power button may also change the power level. The first press will show you the current power level. Press the power button repeatedly to change power level. All settings can be changed during cooking if you so desire.

**Power level**

Microwaves only	
Power	Suggested use:
750 W	Reheating of beverages, water, clear soups, coffee, tea or other food with a high water content. If the food contains egg or cream choose a lower power. Cooking of fish, vegetables, meat etc.
500 W	More careful cooking e.g. high protein sauces, cheese and egg dishes and to finish cooking casseroles.
350 W	Simmering stews, melting butter.
160 W	Defrosting. Softening butter, cheeses. Softening Ice cream.
0 W	When using the Timer only.

**Jet start** 

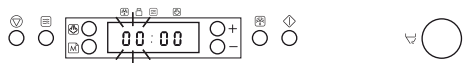

This function is used for quick reheating of foods with a high water content such as; clear soups, coffee or tea.

Press to automatically start with full microwave power level and the cooking time set to 30 seconds. Each additional press increases the time with 30 seconds. You may also alter the time by pressing the +/- buttons to increase or decrease the time after the function has started.

**Manual defrost** 

Follow the procedure for “Cook and reheat with microwaves” and choose power level 160 W when defrosting manually.

Check and inspect the food regularly.

Experience will give you the times needed for various amounts.

Frozen food in plastic bags, plastic films or cardboard packages can be placed directly in the oven as long as the package has no metal parts (e.g. metal twist ties).

The shape of the package alters the defrosting time. Shallow packets defrost more quickly than a deep block.

Separate pieces as they begin to defrost.

Individual slices defrost more easily.

Shield areas of food with small pieces of aluminum foil if they start to become warm (e.g. chicken legs and wing tips).

Turn large joints halfway through the defrosting process.

Boiled food, stews and meat sauces defrost better if stirred during defrosting time.

When defrosting it is better to under-thaw the food slightly and allow the process to finish during standing time.

Standing time after defrosting always improves the result since the temperature will then be evenly distributed throughout the food.

**Jet defrost** 

Use this function for defrosting Meat, Fish & Poultry ONLY. Jet Defrost should only be used if the net weight is between 100 - 2Kg.

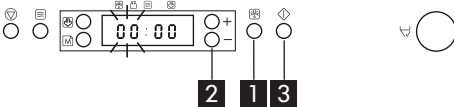

1. Press the Jet Defrost button.
2. Press the + / - buttons to set the weight of the food.
3. Press the Start button.

Midway through the defrosting process the oven stops and prompts you to TURN



**FOOD.**

- Open the door.
- Turn the food.
- Close the door and restart by pressing the Start button.

**NOTE:** The oven continues automatically after 2 min. if the food hasn't been turned. The defrosting time will be longer in this case.

This function needs to know the net weight of the food. The oven will then automatically calculate the needed time to finish the procedure.

- Frozen foods:  
If the food is warmer than deep-freeze temperature (-18°C), choose lower weight of the food.  
If the food is colder than deep-freeze temperature (-18°C), choose higher weight of the food.

Food	Hints
Meat  (100 g - 2.0 Kg)	Minced meat, cutlets, steaks or roasts.
Poultry  (100 g - 2.0 Kg)	Chicken whole, pieces or fillets.
Fish  (100 g - 1.5 Kg)	Whole, steaks or fillets.

For food not listed in this table and if the weight is lesser or greater than recommended weight, you should follow the procedure for “Cook and reheat with microwaves” and choose 160 W when defrosting.

**Memory** 

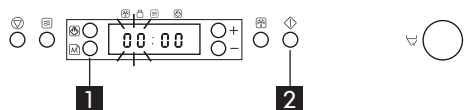

The Memory function provides you with

an easy way to quickly recall a preferred setting.

The principle of the Memory function is to store whatever setting that is currently displayed.

How to activate a stored memory:

1. Press the Memo button.
2. Press the Start button.

How to store a setting:

1. Select any function
2. Make the necessary settings
3. Press and keep the Memo button pressed for 3 seconds until an acoustic signal is heard. The setting is now stored. You may reprogram the memory as many times as you wish.

When the appliance is plugged in or after a power failure, your Memo function will have stored - 1 minutes and 750 W as default setting.

**Steam** 

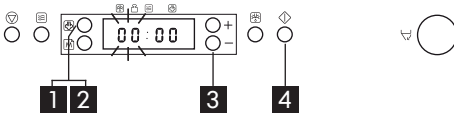

Use this function for such food as vegetables & fish.

Always use the supplied Steamer when using this function.

1. Press the Steam button.
2. Continue to repeatedly press the Steam button to set the food class.
3. Press the +/- buttons to set the weight of the food.
4. Press the Start button.

Place the food on the steam grid.

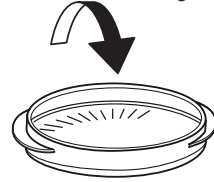

Add 100 ml (1dl) water in the bottom part of the steamer.

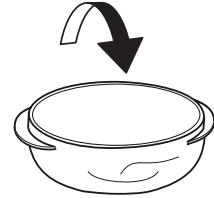



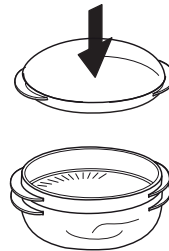

Cover with the lid.



**⚠ WARNING!** The Steamer is designed to be used with microwaves only! Never use it with any other function at all. Using the steamer in any other function may cause damage. Always ensure that the turntable is able to turn freely before starting the oven. Always place the steamer on the Glass Turntable.

**Cooking vegetables**

Place the vegetables into the strainer.  
 Pour 100 ml water into the bottom part.  
 Cover with the lid and set the time.  
 Soft vegetables such as broccoli and leek require 2-3 minutes cooking time.  
 Harder vegetables such as carrots and potatoes require 4-5 minutes cooking time.

Food	Hints
Potatoes / Root vegetables  (150 g - 200 g)	Use even sizes. Cut the vegetables into even pieces. Allow to stand for 1 - 2 minutes, after cooking.
Vegetables (Cauliflower and Broccoli)  (150 g - 500 g)	
Frozen vegetables  (150 g - 500 g)	Allow to stand for 1 - 2 minutes after cooking.
Fish filets  (150 g - 500 g)	Distribute fillets evenly on the steamgrid. Interlace thin parts. Allow to stand for 1 - 2 minutes, after cooking.

During and after use, do not touch the heating elements or interior surface of the appliance - risk of burns. Do not allow the appliance to come in contact with cloths or other flammable materials until all the components have cooled down completely.

**WARNING:** Do not heat or cook with sealed jars or containers in the appliance.

The pressure that builds up inside might cause them to explode, damaging the appliance.

**WARNING:** If the appliance is operated in the combination mode, children should only use the appliance under adult supervision due to the temperatures generated.

**WARNING :** Overheating the liquid beyond boiling point can occur without evidence of bubbling. This could result in a sudden boil over of the hot liquid. To prevent this possibility the following steps should be taken :

1. Avoid using straight-sided containers with narrow necks.
2. Stir the liquid before placing the container in the appliance and let the teaspoon remain in the container.
3. After heating, allow standing for a short time, stirring again before carefully removing the container from the appliance.

**WARNING:** After heating baby food of liquids in a baby bottle or in a baby food jar, always stir and check the temperature before serving.

**⚠ WARNING:** The appliance and its accessible parts become hot during use. Care should be taken to avoid touching heating elements. Young children should be kept away.

**What to do if ...**

<b>Problem</b>	<b>Possible cause</b>	<b>Solution</b>
The appliance does not work.	The mains power supply or the appliance is not connected.	Check your fuses and ensure that there is power available.
	The door isn't closed.	Open and then close the door before you try again.
A message is displayed such as: F2, F3C, F7 or Err2, Err3, Err5.	The oven has recognized that a fault has occurred in one of its sensors or similar.	Disconnect and wait 10 minutes before reconnecting, then try to operate the oven once more. If the problem persists: call service.
The food is unevenly heated.	Very thin parts such as chicken wingtips and such are not shielded.	Shield the thinner parts with aluminum foil.
	The food was heated at a power level too high.	Choose a lower power level.
	The turntable has stopped.	Check that the turntable and turntable support is in place and the food is well centered, not touching the cavity walls.
Food isn't turning.	The turntable has stopped.	Check that the turntable and turntable support is in place and the cavity bottom is clean.

**Authorized Service Centre**

Before calling the Authorized Service Centre:

1. See if you can solve the problem on your own (see the "What to do if ..." table).
  2. Switch the appliance off and on again to see if the problem has disappeared.
- If the fault persists after the above checks, contact IKEA Authorized Service Centre.

Always specify:

- the type of fault;
- exact type and model of appliance;
- the Authorized Service Centre number (the number given after the word "Service" on the rating plate) located on the inside edge of the oven cavity (visible when the door is open);
- your full address;
- your telephone number.



If any repairs are required, please contact IKEA Authorized Service Centre (to guarantee that original spare parts will be used and repairs carried out correctly).

**Technical data**

Model identification: MATÅLSKARE 403 687 70 MATTRADITION 603 687 69 ; 104 117 70 ; 304 117 69.	
Supply Voltage	220-240 V/50 Hz
Rated Power Input	1300 W
Fuse	10 A (UK 13 A)
MW output power	750 W
Outer dimensions (HxWxD)	394 x 595 x 320
Cavity inner dimensions (HxWxD)	187 x 370 x 290

The technical informations are situated in the rating plate inside the appliance.

**Data for test heating performance in accordance with IEC 60705.**

The International Electrotechnical Commission, SC. 59H, has developed a standard for comparative testing of heating performance of different microwave ovens.

We recommend the following for this oven:

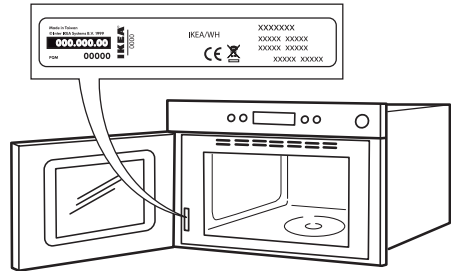

Test	Amount	Approx. time	Power level	Container
12.3.1	750 g	10 min	750 W	Pyrex 3.227
12.3.2	475 g	5 ½ min	750 W	Pyrex 3.827
12.3.3	900 g	14 min	750 W	Pyrex 3.838
13.3	500 g	2 min 40 sec	Jet Defrost	

**NOTE:** this information is only for the qualified technician.

## Installation

### Mounting the appliance

Follow the supplied separate mounting instructions when installing the appliance. Children should not perform installation operations. Keep children away during installation of the appliance. Keep the packaging materials (plastic bags, polystyrene parts, etc.) out of reach of children, during and after the installation of the appliance.

Use protective gloves to perform all unpacking and installation operations. The appliance must be handled and installed by two or more persons. The appliance must be disconnected from the power supply before carrying out any installation operation.

After unpacking the appliance, make sure that it has not been damaged during transport. In the event of problems, contact the dealer or your nearest After-sales Service.

After unpacking the appliance, make sure that the appliance door closes properly. In the event of problems, contact the dealer or your nearest After-sales Service. To prevent any damage, only remove the oven from its polystyrene foam base at the time of installation.

During installation, make sure the appliance does not damage the power cable.



## Electrical connection

### Prior to connecting

Check that the voltage on the rating plate corresponds to the voltage in your home. The rating plate is on the front edge of the oven (visible when the door is open). Do not remove the microwave inlet protection plates located on the side of the oven cavity walls. They prevent grease and food particles from entering the microwave inlet channels.

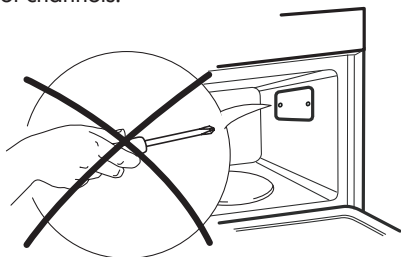

Ensure the oven cavity is empty before mounting.

Ensure that the appliance is not damaged. Check that the oven door closes firmly against the door support and that the internal door seal is not damaged. Empty the oven and clean the interior with a soft, damp cloth. Do not operate this appliance if it has a damaged mains cord or plug, if it is not working properly, or if it has been damaged or dropped. Do not immerse the mains cord or plug in water. Keep the cord away from hot surfaces. Electrical shock, fire or other hazards may result.

### After connecting

The oven can be operated only if the oven door is firmly closed.

Regulation require that the appliance is earthed.

The manufacturer will accept no responsibility for injury to persons, animals or damage to objects arising from the non-observance of this requirement.

The manufacturers are not liable for any problems caused by the user's failure to observe these instructions. Failure to observe these instructions may lead to risks. The Manufacturer declines any liability for injury to persons or animals or damage to property if these advices and precautions are not respected.

**CAUTION:** The appliance is not intended to be operated by means of an external timer or separate remote control system.

After installation, the electrical components must not be accessible to the user.

For installation to comply with current safety regulations, an omnipolar switch with minimum contact gap of 3mm is required.

**WARNING :** The power cable must be long enough for connecting the appliance, once fitted in its housing, to the main power supply.

Do not pull the power supply cable.

If the power cable is damaged it must be replaced with an identical one. The power cable must only be replaced by a qualified technician in compliance with the manufacturer instruction and current safety regulations. Contact an authorized service center.

Do not operate this appliance if it has a damaged mains cord or plug, if it is not working properly, or if it has been damaged or dropped. Do not immerse the mains cord or plug in water. Keep the cord away from hot surfaces.

Do not touch the appliance with any wet part of the body and do not operate it when barefoot.

For appliances with fitted plug, if the plug is not suitable for you socket outlet, contact a qualified technician.

Do not use extension leads, multiple sockets or adapters. Do not connect the appliance to a socket which can be operated by remote control.

## Environmental concerns

**⚠ WARNING!** It is hazardous for anyone other than a competent person to carry out any service or repair operation that involves the removal of a cover which give protection against exposure to microwave energy.

**⚠ WARNING!** Failure to maintain the oven in a clean condition could lead to deterioration of the surface that could adversely affect the life of the appliance and possibly result in a hazardous situation.

**⚠ WARNING!** The oven shall be cleaned regularly and any food deposits removed.

**⚠ WARNING!** Ensure that the appliance is switched off and disconnected from the power supply before performing any maintenance operation - risk of electrical shock. Never use steam cleaning equipment.

**⚠ WARNING!** Do not use harsh abrasive cleaners or metal scrapers to clean the door glass since they can scratch the surface, which may result in shattering of the glass.

**⚠** Ensure the appliance is cooled down before any cleaning or maintenance. - risk of burn

**⚠ WARNING!** Switch off the appliance before replacing the lamp - risk of electrical shock.

## DISPOSAL OF PACKAGING MATERIALS

The packaging material is 100% recyclable and is marked with the recycle symbol.  The various parts of the packaging must therefore be disposed of responsibly and in full compliance with local authority regulations governing waste disposal.

## SCRAPPING OF HOUSEHOLD APPLIANCES

This appliance is manufactured with recyclable or reusable materials. Dispose of it in accordance with local waste disposal regulations. For further information on the treatment, recovery and recycling of household electrical appliances, contact your local authority, the collection service for household waste or the store where you purchased the appliance. This appliance is marked in compliance with European Directive 2012/19/EU, Waste Electrical and Electronic Equipment (WEEE). By ensuring this product is disposed of correctly, you will help prevent negative consequences for the environment and human health.

The symbol  on the product or on the accompanying documentation indicates that it should not be treated as domestic waste but must be taken to an appropriate collection center for the recycling of electrical and electronic equipment.

## ENERGY SAVING TIPS

Only preheat the oven if specified in the cooking table or your recipe. Use dark lacquered or enamelled baking trays as they absorb heat better. Food requiring prolonged cooking will continue to cook even once the oven is switched off.



## IKEA GUARANTEE

### How long is the IKEA guarantee valid?

This guarantee is valid for five years from the original date of purchase of your appliance at IKEA. The original sales receipt, is required as proof of purchase. If service work is carried out under guarantee, this will not extend the guarantee period for the appliance.

### Who will execute the service?

IKEA service provider will provide the service through its own service operations or authorized service partner network.

### What does this guarantee cover?

The guarantee covers faults of the appliance, which have been caused by faulty construction or material faults from the date of purchase from IKEA. This guarantee applies to domestic use only. The exceptions are specified under the headline "What is not covered under this guarantee?" Within the guarantee period, the costs to remedy the fault e.g. repairs, parts, labour and travel will be covered, provided that the appliance is accessible for repair without special expenditure. On these conditions the EU guidelines (Nr. 99/44/EG) and the respective local regulations are applicable. Replaced parts become the property of IKEA.

### What will IKEA do to correct the problem?

IKEA appointed Service Provider will examine the product and decide, at its sole discretion, if it is covered under this guarantee. If considered covered, IKEA Service Provider or its authorized service partner through its own service operations, will then, at its sole discretion, either repair the defective product or replace it with the same or a comparable product.

### What is not covered under this guarantee?

- Normal wear and tear.
- Deliberate or negligent damage, damage caused by failure to observe operating instructions, incorrect installation or by connection to the wrong voltage, damage caused by chemical or electrochemical reaction, rust, corrosion or water damage including but not

limited to damage caused by excessive lime in the water supply, damage caused by abnormal environmental conditions.

- Consumable parts including batteries and lamps.
- Non-functional and decorative parts which do not affect normal use of the appliance, including any scratches and possible color differences.
- Accidental damage caused by foreign objects or substances and cleaning or unblocking of filters, drainage systems or soap drawers.
- Damage to the following parts: ceramic glass, accessories, crockery and cutlery baskets, feed and drainage pipes, seals, lamps and lamp covers, screens, knobs, casings and parts of casings. Unless such damages can be proved to have been caused by production faults.
- Cases where no fault could be found during a technician's visit.
- Repairs not carried out by our appointed service providers and/or an authorized service contractual partner or where non-original parts have been used.
- Repairs caused by installation which is faulty or not according to specification.
- The use of the appliance in a non-domestic environment i.e. professional use.
- Transportation damages. If a customer transports the product to his home or another address, IKEA is not liable for any damage that may occur during transport. However, if IKEA delivers the product to the customer's delivery address, then damage to the product that occurs during this delivery will be covered by IKEA.
- Cost for carrying out the initial installation of the IKEA appliance.
- However, if an IKEA appointed Service Provider or its authorized service partner repairs or replaces the appliance under the terms of this guarantee, the appointed Service Provider or its authorized service partner will reinstall the repaired appliance or install the replacement, if necessary.

- This does not apply within Ireland, customer should contact the local IKEA dedicated after sales line or the appointed Service Provider for further information.

**(just for GB)**

These restrictions do not apply to fault-free work carried out by a qualified specialist using our original parts in order to adapt the appliance to the technical safety specifications of another EU country.

### How country law applies

The IKEA guarantee gives you specific legal rights, which cover or exceed all the local legal demands. However these conditions do not limit in any way consumer rights described in the local legislation.

### Area of validity

For appliances which are purchased in one EU country and taken to another EU country, the services will be provided in the framework of the guarantee conditions normal in the new country.

An obligation to carry out services in the framework of the guarantee exists only if the appliance complies and is installed in accordance with:

- the technical specifications of the country in which the guarantee claim is made;
- the Assembly Instructions and User Manual Safety Information.

### The dedicated AFTER SALES for IKEA appliances

Please don't hesitate to contact IKEA appointed Authorized Service Centre to:

- make a service request under this guarantee;
- ask for clarifications on installation of the IKEA appliance in the dedicated IKEA kitchen furniture;
- ask for clarification on functions of IKEA appliances.

To ensure that we provide you with the best assistance, please read carefully the Assembly Instructions and/or the User Manual before contacting us.

### How to reach us if you need our service



Please refer to the last page of this manual for the full list of IKEA appointed Authorized Service Centre and relative national phone numbers.

**i** In order to provide you a quicker service, we recommend to use the specific phone numbers listed on this manual. Always refer to the numbers listed in the booklet of the specific appliance you need an assistance for. Please also always refer to the IKEA article number (8 digit code) and 12 digit service number placed on the rating plate of your appliance.

**i** **SAVE THE SALES RECEIPT!**  
It is your proof of purchase and required for the guarantee to apply. The sales receipt also reports the IKEA name and article number (8 digit code) for each of the appliances you have purchased.

### Do you need extra help?

For any additional questions not related to After Sales of your appliances please contact your nearest IKEA store call centre. We recommend you read the appliance documentation carefully before contacting us.